

Description

PECJ P-channel Enhancement Mode Power MOSFET

Features

- $V_{DS} = -20V$, $I_D = -0.66A$
 $R_{DS(ON)} < 0.52\Omega @ V_{GS} = -4.5V$
 $R_{DS(ON)} < 0.7\Omega @ V_{GS} = -2.5V$
- Advanced Trench Technology
- Excellent $R_{DS(ON)}$ and Low Gate Charge
- Lead free product is acquired
- ESD Protected: HBM 2KV

Application

- PWM Applications
- Load Switch
- Power Management

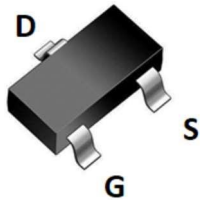

SOT-23 top view



Marking and pin Assignment

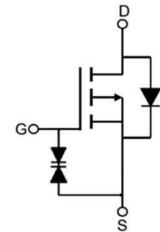

Schematic Diagram

Package Marking and Ordering Information

Device Marking	Device	OUTLINE	Device Package	Reel Size	Reel (PCS)	Per Carton (PCS)
04K	PECJ2004KT2	TAPING	SOT-23	-	-	-

Absolute Maximum Ratings ($T_A=25^\circ C$ unless otherwise specified)

Symbol	Parameter	Max.	Units
V_{DSS}	Drain-Source Voltage	-20	V
V_{GSS}	Gate-Source Voltage	± 10	V
I_D	Continuous Drain Current	$T_A = 25^\circ C$	-0.66
		$T_A = 100^\circ C$	-0.43
I_{DM}	Pulsed Drain Current <small>note1</small>	-2.64	A
P_D	Power Dissipation	$T_A = 25^\circ C$	0.35
$R_{\theta JA}$	Thermal Resistance, Junction to Ambient	357	$^\circ C/W$
T_J, T_{STG}	Operating and Storage Temperature Range	-55 to +150	$^\circ C$

Electrical Characteristics (T_J=25°C unless otherwise specified)

Symbol	Parameter	Test Condition	Min.	Typ.	Max.	Units
Off Characteristic						
V _{(BR)DSS}	Drain-Source Breakdown Voltage	V _{GS} =0V, I _D = -250μA	-20	-	-	V
I _{DSS}	Zero Gate Voltage Drain Current	V _{DS} = -20V, V _{GS} =0V,	-	-	-1	μA
I _{GSS}	Gate to Body Leakage Current	V _{DS} =0V, V _{GS} = ±10V	-	-	±10	uA
On Characteristics						
V _{GS(th)}	Gate Threshold Voltage	V _{DS} =V _{GS} , I _D = -250μA	-0.35	-0.65	-1.0	V
R _{DS(on)}	Static Drain-Source on-Resistance <small>note2</small>	V _{GS} = -4.5V, I _D = -0.5A	-	0.36	0.52	Ω
		V _{GS} = -2.5V, I _D = -0.2A	-	0.5	0.7	
Dynamic Characteristics						
C _{iss}	Input Capacitance	V _{DS} = -16V, V _{GS} =0V, f=1.0MHz	-	113	-	pF
C _{oss}	Output Capacitance		-	15	-	pF
C _{rss}	Reverse Transfer Capacitance		-	9	-	pF
Q _g	Total Gate Charge	V _{DS} = -10V, I _D = -0.3A, V _{GS} = -4.5V	-	9.8	-	nC
Q _{gs}	Gate-Source Charge		-	1.6	-	nC
Q _{gd}	Gate-Drain("Miller") Charge		-	3.4	-	nC
Switching Characteristics						
t _{d(on)}	Turn-on Delay Time	V _{DD} = -10V, I _D = -0.2A, R _G =10Ω, V _{GS} = -4.5V	-	9	-	ns
t _r	Turn-on Rise Time		-	5.7	-	ns
t _{d(off)}	Turn-off Delay Time		-	32.6	-	ns
t _f	Turn-off Fall Time		-	20.3	-	ns
Drain-Source Diode Characteristics and Maximum Ratings						
I _S	Maximum Continuous Drain to Source Diode Forward Current		-	-	-0.66	A
I _{SM}	Maximum Pulsed Drain to Source Diode Forward Current		-	-	-2.64	A
V _{SD}	Drain to Source Diode Forward Voltage	V _{GS} =0V, I _S = -0.5A	-	-	-1.2	V

Notes:1. Repetitive Rating: Pulse Width Limited by Maximum Junction Temperature

2. Pulse Test: Pulse Width≤300μs, Duty Cycle≤2%

Typical Performance Characteristics

Figure 1: Output Characteristics

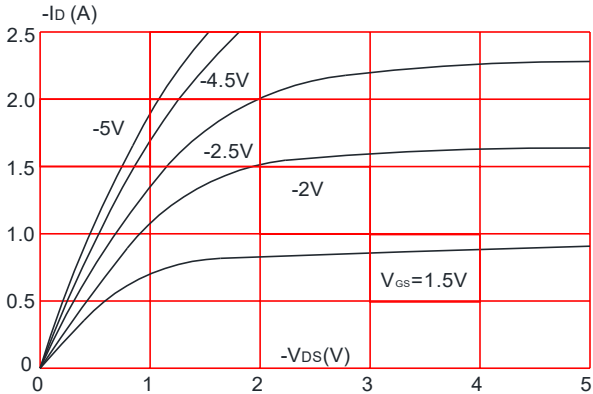

Figure 2: Typical Transfer Characteristics

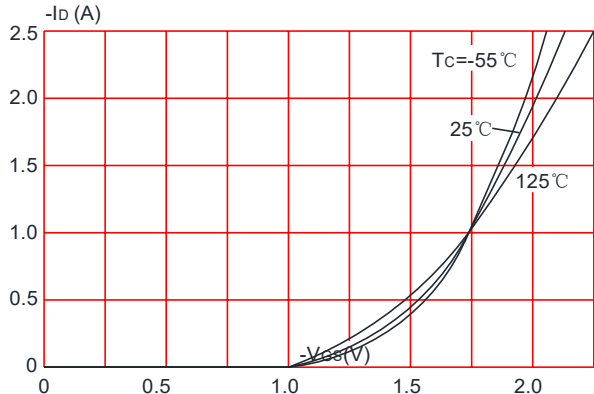

Figure 3: On-resistance vs. Drain Current

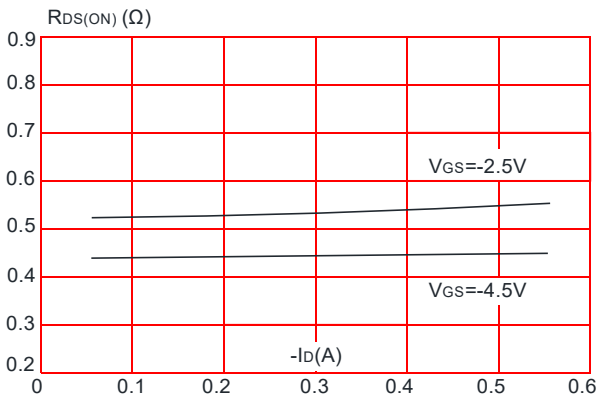

Figure 4: Body Diode Characteristics

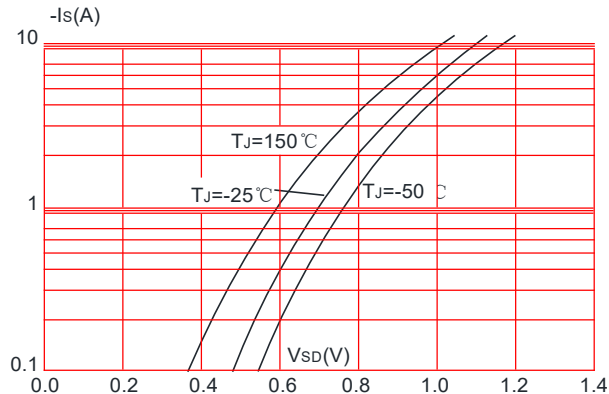

Figure 5: Gate Charge Characteristics

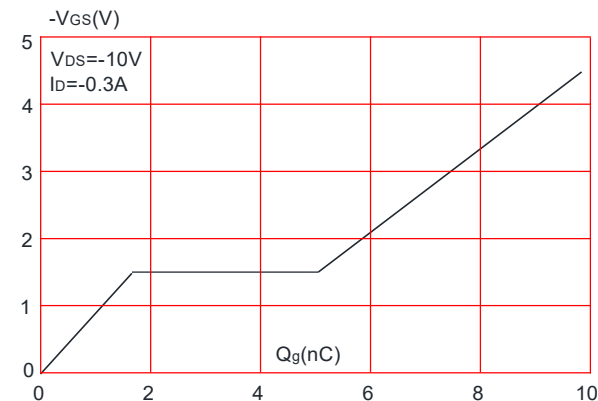

Figure 6: Capacitance Characteristics

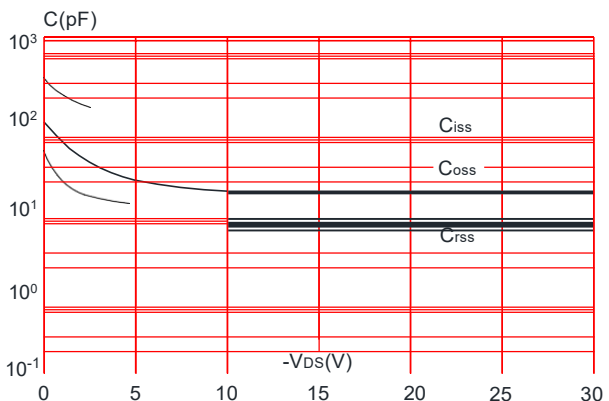

Figure 7: Normalized Breakdown Voltage vs. Junction Temperature

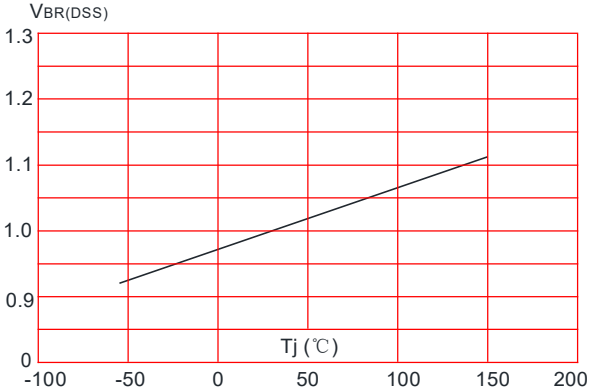

Figure 8: Normalized on Resistance vs. Junction Temperature

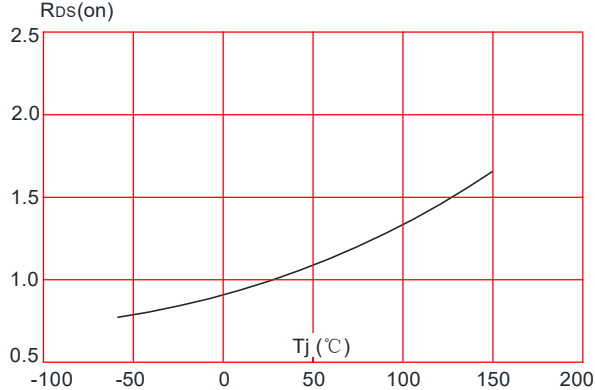

Figure 9: Maximum Safe Operating Area

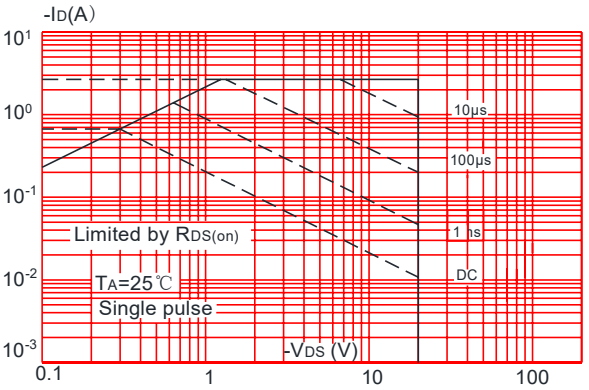

Figure 10: Maximum Continuous Drain Current vs. Ambient Temperature

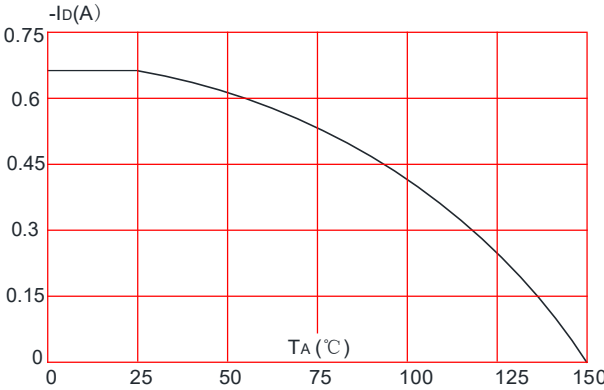
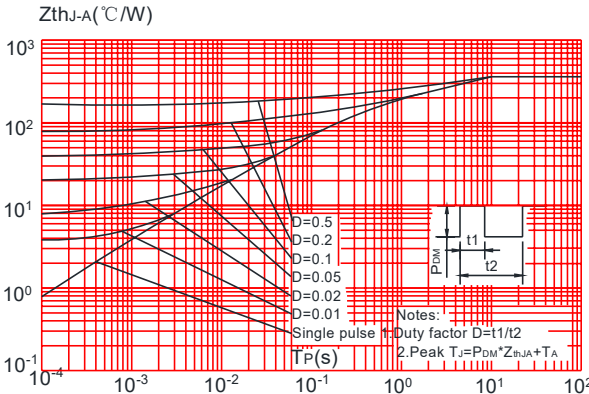
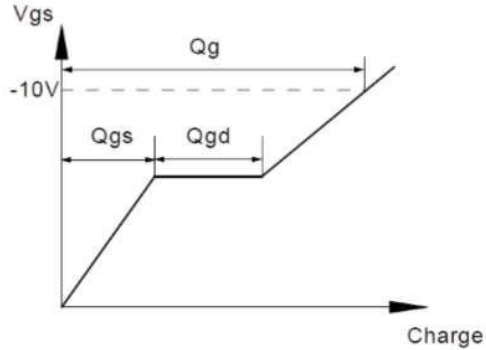
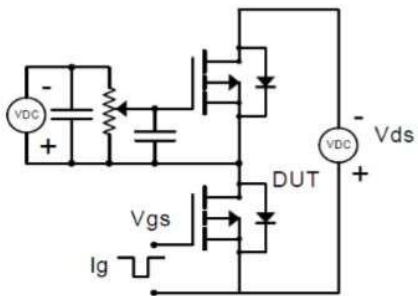

Figure.11: Maximum Effective Transient Thermal Impedance, Junction-to-Ambient



Test Circuit

Gate Charge Test Circuit & Waveform



Resistive Switching Test Circuit & Waveforms

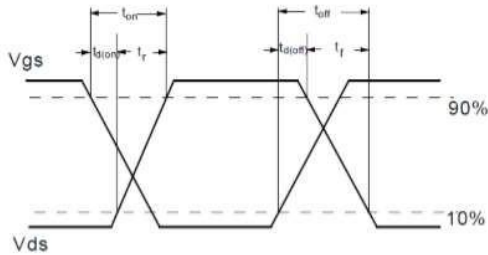
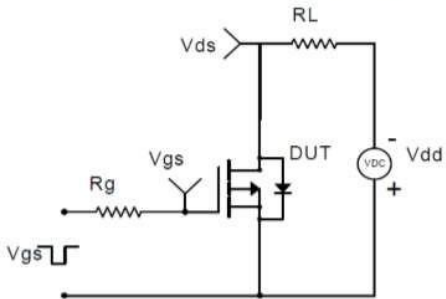

Unclamped Inductive Switching (UIS) Test Circuit & Waveforms

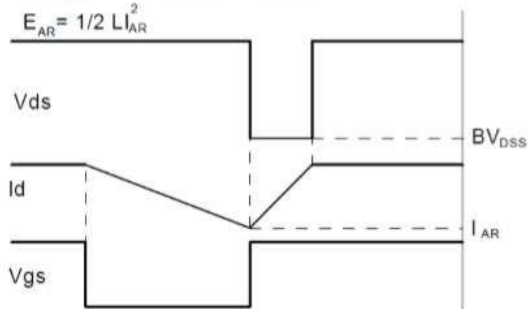
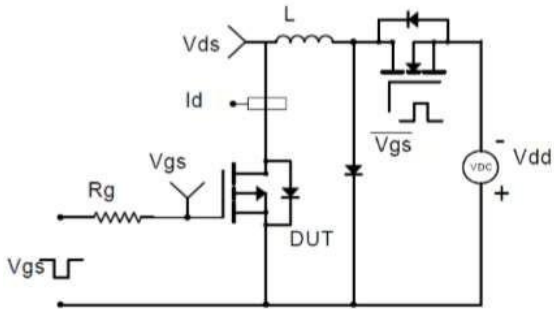

Diode Recovery Test Circuit & Waveforms

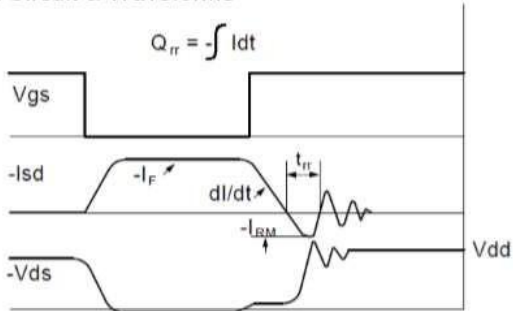
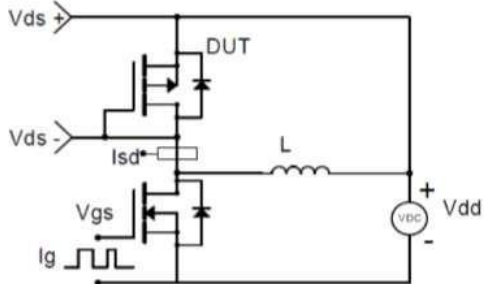

Package Mechanical Data-SOT-23

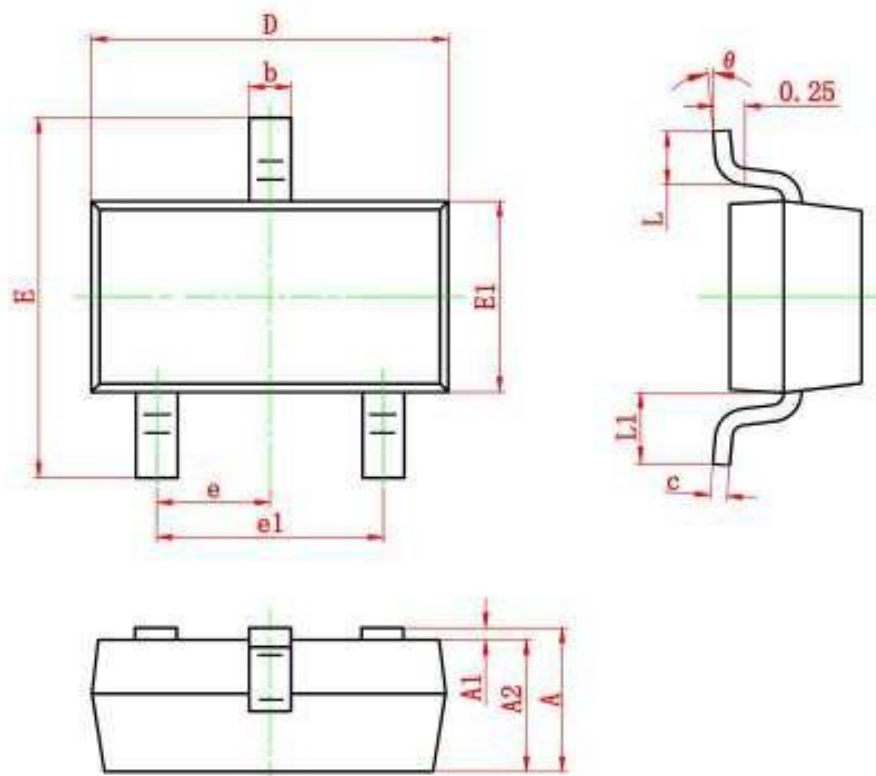

Symbol	Dimensions In Millimeters	
	Min.	Max.
A	0.90	1.15
A1	0.00	0.10
A2	0.90	1.05
b	0.30	0.50
c	0.08	0.15
D	2.80	3.00
E	1.20	1.40
E1	2.25	2.55
e	0.95 REF.	
e1	1.80	2.00
L	0.55 REF.	
L1	0.30	0.50
θ	0°	8°